

COME IN FROM THE COLD.

NEW FOR '98!  
SEE-THRU AND PENINSULA  
FIREBOXES

VENT-FREE LOGMATE™ FIREBOXES AND STOVE

*Vanguard Fireboxes Are  
Approved For Use With Any  
Vent-Free Logs\**

**VANGUARD**

VENT-FREE GAS HEARTH PRODUCTS

# CREATE A CUSTOM VENT-FREE GAS FIREPLACE

## ...INSTANTLY!

### *A Perfect Match....the LogMate Firebox and Vanguard Vent-Free Gas Log Heater of Your Choice.*

A LogMate Firebox or Stove by Vanguard allows you to enjoy the beauty of a fireplace along with the warmth and efficiency of a vent-free gas space heater...instantly. And at a fraction of the cost of a wood burning fireplace.

Pair a LogMate with any Vanguard (or other brand of) Vent-Free Gas Log Heater\* of your choice. The fireboxes may be installed against (or recessed into) any wall accessible to a gas line. The stove is freestanding. The LogMates and the clean burning 99% heating efficient logs require no chimney or outside venting, so all the heat stays in the room.

### *Beautiful Choices.*

All standard LogMate Fireboxes are offered in two styles. The heat circulating fireboxes feature louvers and can be fitted with the optional blower. The smooth face non-circulating model is ideal for custom trim applications such as stone or marble.

All fireboxes feature an attractive textured charcoal paint finish, hood and wire mesh firescreen. The 36" and 42" models feature a unique lightweight concrete liner and floor. The 32" fireboxes include a fiber ceramic liner.

The new see-thru and peninsula LogMate Fireboxes offer versatile and creative ways to install a fireplace in your home. Both also include a charcoal textured paint finish, louvers, hoods and firescreens. The firebox side(s) are lined in fiber ceramic brick panels. The optional blower can be installed.

### *Accessories to Complete the Look.*

Customize your 32" LogMate Vent-Free Firebox with a variety of optional mantels, marble laminate trim kits, and/or brass hood. Beautifully designed mantels are available in standard cabinet and space saving corner designs, in an assortment of finished, painted and unfinished hardwood and oak. Unfinished mantels are ready to stain or paint. Optional hearth bases in hardwood, oak or slim marble laminates are also available for the 32" LogMate.

Optional unfinished cabinet mantels, brass accent trim and brass hoods are offered for the 36" and 42" LogMate Fireboxes. Brass louvers kits are available for the see-thru and peninsula fireboxes. A firebox top in unfinished oak is available for the Peninsula Firebox.

Attractive polished brass firebox perimeter trim is included with every LogMate mantel. The perimeter brass trims are also available separately for custom installations and offer an easy way to cover unfinished edges around fireboxes.

\* All Vanguard LogMate Fireboxes are approved as Universal fireboxes and can be paired with any manufacturer's ANSI Z21.12 approved vent-free log (physical size limitations apply). 42" LogMate Fireboxes can be paired with any standard Vanguard Log. The 36" LogMate will accept any 18", 24" or 30" log. Only 18" and 24" Vanguard Logs can be installed in a 32" LogMate. An 18" Log can be installed in the LogMate Stove. The multi-sided log installs in the see-thru or peninsula firebox.

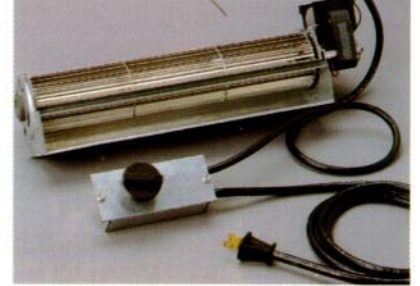

*The optional GA3700 blower accessory can be installed in any circulating louvered LogMate Firebox or the stove to maximize heat distribution. Features a variable speed control.*



**NEW FOR '98  
OFF-WHITE MANTEL  
AND BASE**

▲ *32" Circulating Firebox with off-white cabinet mantel and beartb base. Shown with optional laminate trims and 24" Split Oak Gas Log Heater.*



▶ *Freestanding LogMate Stove features a hinged door for easy access. Manual blower available. Shown with 18" Split Oak Gas Log Heater.*

▶ *36" Circulating LogMate Firebox shown recessed with custom mantel, optional perimeter brass trim accessory and 24" Flame-Max Golden Oak Gas Log Heater.*

NEW FOR '98



▲ Versatile see-thru firebox shown with optional brass louvers, perimeter brass trim and the Vanguard Vent-Free Multi-Sided Gas Log Heater.

Now With  
STRONGER BRICK  
LINER AND FLOOR!

Pair a LogMate with any of these attractive  
Vanguard Vent-Free Gas Log Heaters.



Flame-Max™ Golden Oak



Flame-Max™ Vintage Oak



CharRealistic™ Split Oak



Flame-Max™ Birch

Any LogMate firebox may be purchased without a mantel for use in custom installations. 36" Firebox shown with optional brass accent trim accessory.

**LOGMATE™ VENT-FREE FIREBOXES AND STOVE**

MODEL NUMBER	DESCRIPTION	OUTSIDE DIMENSIONS	SHIPPING WT.
FB32C	32" Circulating Louvered Firebox includes black hood, fiber ceramic brick liner, wire mesh firescreen and duplex outlet.	35 1/16" W x 32 3/16" H x 19 1/4" D	71 lbs.
FB32NC	32" Non-Circulating Smooth Face Firebox includes black hood, fiber ceramic brick liner and wire mesh firescreen. Does Not accept blower.	35 1/16" W x 33 11/16" H x 19 1/4" D	71 lbs.
FB36C	36" Circulating Louvered Firebox includes black hood, concrete brick liner and floor, wire mesh firescreen and duplex outlet.	41 3/4" W x 36 1/2" H x 22 1/4" D	140 lbs.
FB36NC	36" Non-Circulating Smooth Face Firebox includes black hood, concrete brick liner and floor and wire mesh firescreen. Does Not Accept Blower.	41 3/4" W x 36 1/2" H x 22 1/4" D	140 lbs.
FB42C	42" Circulating Louvered Firebox includes black hood, concrete brick liner and floor, wire mesh firescreen and duplex outlet.	47 3/4" W x 36 1/2" H x 22 1/4" D	150 lbs.
FB42NC	42" Non-Circulating Smooth Face Firebox includes black hood, concrete brick liner and floor and wire mesh firescreen. Does Not Accept Blower.	47 3/4" W x 36 1/2" H x 22 1/4" D	150 lbs.
FBST	36" Circulating Louvered See-Thru Firebox includes black hoods, fiber ceramic brick liner sides, wire mesh firescreens for two openings and duplex outlet.	41 3/4" W x 34 1/2" H x 27" D	80 lbs.
FBPS	36" Circulating Louvered Peninsula Firebox includes black hoods, fiber ceramic brick liner side, wire mesh firescreens for two openings plus one end and duplex outlet.	41 3/4" W x 34 1/2" H x 27" D	80 lbs.
SVFBC	Stove, Circulating includes wire mesh firescreen.	28" W x 31 5/8" H x 18 1/2" D	89 lbs.

NEW

VENT-FREE LOGMATE FIREBOXES AND STOVE

ACCESSORIES FOR 32" LOGMATE FIREBOXES ONLY		OUTSIDE DIMENSIONS	SHIPPING WT.
MODEL NO	DESCRIPTION		
GA3700	Manual Blower, Variable Speed Control. (Fits all circulating models and stove.)	N/A	5 lbs.
GM100F	Cabinet Mantel, with Firebox Perimeter Brass Trim, Walnut Finished Hardwood*	56 3/4" W x 48 3/4" H x 20 5/8" D	85 lbs.
GM101U	Cabinet Mantel, with Firebox Perimeter Brass Trim, Unfinished Hardwood (Ready to stain or paint.)*	56 3/4" W x 48 3/4" H x 20 5/8" D	85 lbs.
GM106F	Cabinet Mantel, with Firebox Perimeter Brass Trim, Finished Oak Veneer Over Hardwood*	56 3/4" W x 48 3/4" H x 20 5/8" D	85 lbs.
GM107U	Cabinet Mantel, with Firebox Perimeter Brass Trim, Unfinished Oak Veneer Over Hardwood (Ready to stain or paint.)*	56 3/4" W x 48 3/4" H x 20 5/8" D	85 lbs.
<b>NEW</b> GM102W	Cabinet Mantel, with Firebox Perimeter Brass Trim, Off White Paint Finish*	56 3/4" W x 48 3/4" H x 34 5/8" D	85 lbs.
GM200F	Corner Mantel, with Firebox Perimeter Brass Trim, Walnut Finished Hardwood*	60 7/8" W x 48 3/4" H x 34 5/8" D	74 lbs.
GM201U	Corner Mantel, with Firebox Perimeter Brass Trim, Unfinished Hardwood (Ready to stain or paint.)*	60 7/8" W x 48 3/4" H x 34 5/8" D	74 lbs.
G3002J/S/B	Mantel Trim, Jade/Sandstone/or Black Onyx Marble Laminate (Fits all mantels.)	3 1/8" W	2 lbs.
G3000F	Hearth Base, Walnut Finished Hardwood (Can only be used with Cabinet Mantel.)	58" W x 6 1/2" H x 28 9/16" D	65 lbs.
G3001U	Hearth Base, Unfinished Hardwood (Ready to stain or paint. Can only be used with Cabinet Mantel.)	58" W x 6 1/2" H x 28 9/16" D	65 lbs.
G3006F	Hearth Base, Finished Oak Veneer Over Hardwood (Can only be used with Cabinet Mantel.)	58" W x 6 1/2" H x 28 9/16" D	65 lbs.
G3007U	Hearth Base, Unfinished Oak Veneer Over Hardwood (Ready to Stain or Paint. Can only be used with Cabinet Mantel.)	58" W x 6 1/2" H x 28 9/16" D	65 lbs.
<b>NEW</b> G3004W	Hearth Base, Off White Paint Finish (Can only be used with Cabinet Mantel.)	58" W x 6 1/2" H x 28 9/16" D	65 lbs.
G3003J/S/B	Hearth Base Trim, Jade/Sandstone/or Black Onyx Marble Laminate (Fits Hardwood Bases only.)	56 3/4" W x 28" D	6 lbs.
G3005J/S/B	Slim Hearth Base, Jade/Sandstone/or Black Onyx Marble Laminate (Fits all mantels.)	41 7/8" W x 5/8" H x 10" D	10 lbs.
GA6090	32" Firebox Perimeter Brass Trim Kit (Not required with Vanguard Mantels)	N/A	2 lbs.
GA6096	32" Brass Hood	31 5/8" W x 2 3/4" D	6 lbs.
ACCESSORIES FOR 36" and 42" LOGMATE FIREBOXES ONLY			
GA3700	Manual Blower, Variable Speed Control. (Fits all circulating models and stove.)	N/A	5 lbs.
GM103U	Cabinet Mantel, with Firebox Perimeter Brass Trim, Unfinished Hardwood (Ready to stain or paint.)* Fits FB36 Series Fireboxes*	63" W x 51" H x 24 1/2" D	120 lbs.
GM105U	Cabinet Mantel, with Firebox Perimeter Brass Trim, Unfinished Hardwood (Ready to stain or paint.)* Fits FB42 Series Fireboxes*	69" W x 51" H x 24 1/2" D	130 lbs.
<b>NEW</b> GA6088	36" Brass Accent Trim	N/A	4 lbs.
<b>NEW</b> GA6089	42" Brass Accent Trim	N/A	5 lbs.
GA6091	36" Firebox Perimeter Brass Trim Kit (Not Required with Vanguard Mantels.)	N/A	2 lbs.
GA6092	42" Firebox Perimeter Brass Trim Kit (Not Required with Vanguard Mantels.)	N/A	2 lbs.
<b>NEW</b> GA6097	36" Brass Hood	36" W x 2 3/4" D	6 lbs.
<b>NEW</b> GA6098	42" Brass Hood	42" W x 2 3/4" D	6 lbs.
ACCESSORIES FOR SEE-THRU AND PENINSULA FIREBOXES ONLY			
GA3700	Manual Blower, Variable Speed Control.	N/A	5 lbs.
D9041	Firebox Perimeter Brass Trim Kit (Kit is for one side of firebox.) For Use with See-Through Firebox Only	N/A	5 lbs.
<b>NEW</b> GBL41	Brass Louver Kit (Kit is for one side of fireboxes.)	N/A	5 lbs.
<b>NEW</b> GT109U	Peninsula Firebox Top, Unfinished Oak Veneer Over Hardwood (Ready to Stain or Paint.)	43" W x 51 1/2" H x 27" D	50 lbs.

### 32" Fireboxes

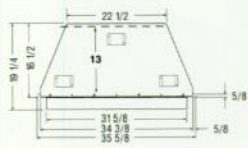

\*Inside depth dimension measured from the Firebox screen (closed) to the back brick liner.

Gas Line Access

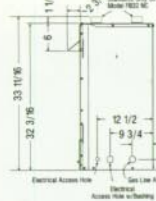

NOTE: Materials expand or contract due to weather conditions, etc. All measurements are estimates. Check actual product for size.

### 36" and 42" Fireboxes

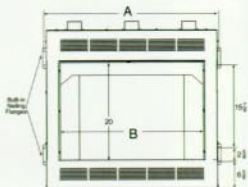

\*Inside depth dimension measured from the raised edge of the brick bottom to the back brick liner.

Side View for Both 36" and 42" Models

	A	B	C	D	E
36" Models	41"	36"	36"	41"	42 1/2"
42" Models	47"	42"	42"	47"	48 1/2"

Top standoffs may not be included. Check actual product.

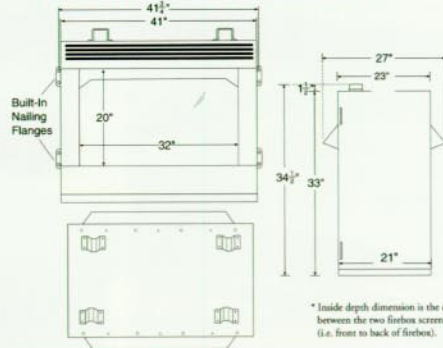

**See-Thru and Peninsula Fireboxes**  
Peninsula Firebox is Open (includes firescreen) on One End.

\* Inside depth dimension is the distance between the two firebox screens (i.e. front to back of firebox).

### 32" Cabinet Mantels

Includes Firebox Perimeter Brass Trim  
GM100F, GM101U, GM102W, GM106F, GM107U

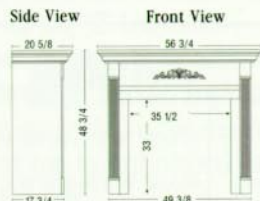

### 32" Corner Mantel

Includes Firebox Perimeter Brass Trim  
GM200F, GM201U



### 36" and 42" Cabinet Mantels

Includes Firebox Perimeter Brass Trim  
GM103U, GM105U

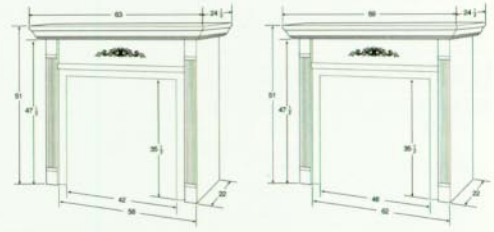

### IMPORTANT

Installation must be done by qualified service persons.  
Read Owner's Manual before using.  
Check local codes and ordinances for permitted uses.  
All products approved for manufactured (mobile) home installation.  
We reserve the right to amend product specifications without notice.  
Operating heater at elevations above 4,500 ft. could cause nuisance outages.

Use with adequate air (ventilation) only. Humidifies while it heats. Provides water vapor in the area heated. Refer to owner's manual for specifics.  
Product cannot be converted between fuel types.  
The only warranty we offer is our standard warranty. Please read the warranty for any limitations or disclaimers.  
All parts have a limited three year warranty. Stainless Steel burners carry a limited five year warranty. All accessories have a one year warranty.

**VANGUARD** DESA INTERNATIONAL



Bowling Green, KY 42101  
(800) 432-2382

